

Article number: 2030100M10100A1SK  
 Description: E+G levelling foot  
 GN 30-100-M10-100-A1-SK  
 Note: SK With nut, External hexagon at the bottom

## Measures

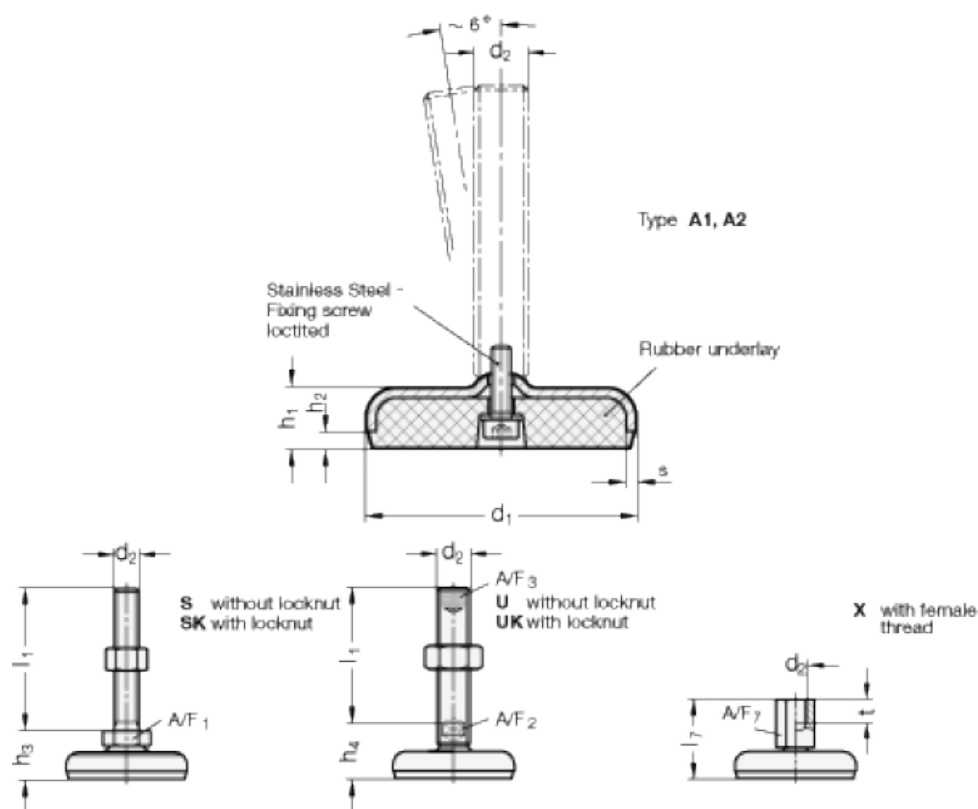

A/F1 = 17  
 d1 = 100  
 d2 = M10  
 h1 = 20  
 h2 = 6  
 h3 = 28  
 l1 = 100  
 s = 3